

Article number: 439700200

Description: Rota-fix shaft-hub connection FL200x305

Note: Self centering - very high torque

Measures

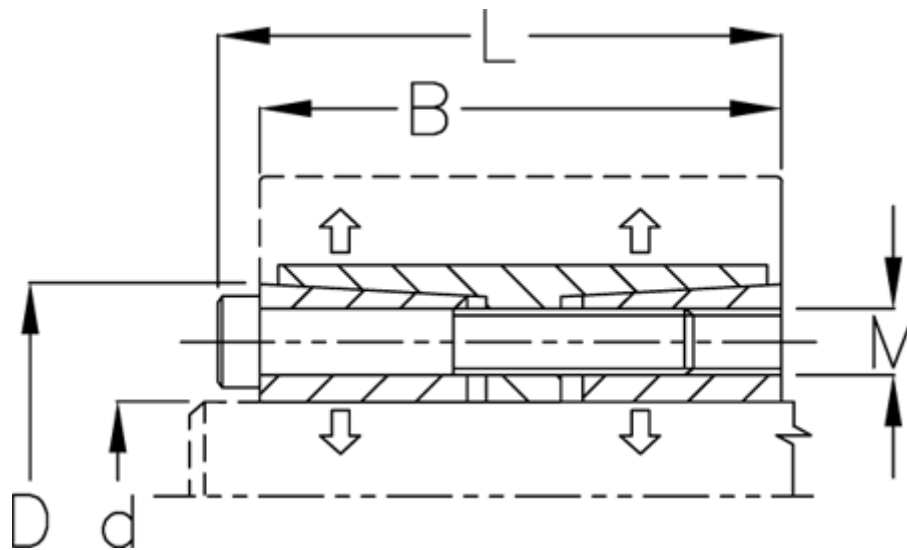

B mm	= 229
d H8 mm	= 200
D mm	= 305
Fit tolerance	= Aksel h8, Nav H8
F kN torque	= 2850.0
L mm	= 251
M mm	= M22
P N/mm ² surface pressure on shaft/hub	= 137

Surface roughness	= R? ? 3.2 μ m
T N m torque	= 285000
Ts N m bolt tightening torque	= 930.0